













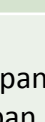









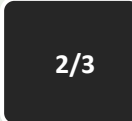
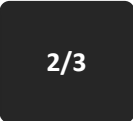















HOSHIZAKI



SANDWICH PREP TABLES

FULL SIZE PAN RAIL CAPACITY

SR27A-8 CRMR27-8    (1) Full size pan* + (2) 1/9 pans *Requires HS-5280	SR48A-8, SR60A-8 CRMR48-8, CRMR60-8   (1) Full size pan + (1) 1/3 pans	   (1) Full size pan + (2) 1/6 pans	    (1) Full size pan + (3) 1/9 pans
SR36A-10 CRMR36-10    (2) 2/3 size pans + (1) 1/3 pan	SR48A-12, SR60A-12, SR72A-12 CRMR48-12, CRMR60-12, CRMR72-12   (2) Full size pans		
SR60A-16, SR72A-16 CRMR60-16, CRMR72-16     (2) Full size pans + (2) 1/3 pans	      (2) Full size pans + (4) 1/6 pans	        (2) Full size pans + (6) 1/9 pans	
SR72A-18 CRMR72-18    (3) Full size pans			

PAN SIZE	FULL SIZE			2/3 SIZE			1/2 SIZE			1/2 SIZE LONG			1/3 SIZE			1/4 SIZE			1/6 SIZE			1/9 SIZE	
	12 3/4"	20 3/4"		13 3/4"	12 3/4"		12 3/4"	10 3/8"		20 3/4"	6 7/16"		12 3/4"	6 7/8"		10 3/8"	6 3/8"		6 7/8"	6 1/4"		6 3/4"	4 1/4"
Pan Depth	2-1/2"	4"	6"	2-1/2"	4"	6"	2-1/2"	4"	6"	2-1/2"	4"	6"	2-1/2"	4"	6"	2-1/2"	4"	6"	2-1/2"	4"	6"	2-1/2"	4"
Cups	36	60	88	24	40	57	16	28	40	16	28	40	10.5	18	26	6.4	12	19	10.5	18	26	2.5	5
Quarts	9	15	22	6	10	14.25	4	7	10	4	7	10	2.6	4.5	6.5	1.6	3	4.75	2.6	4.5	6.5	.63	1.25

- Pans by others. Full complement of 1/6 size pans, 4" deep, and divider bars are included. Pan sizes are industry standard, but actual sizes may vary slightly by manufacturer.

FULL SIZE PAN EQUIVALENCY CHART

																							
--	---	---	---	---	--	---	---	---	---	---	---	---	---	---	---	---	---	---	---	---	---	---	---

- Additional divider bars may be required to accommodate above pan layouts (Individual divider bars sold as Accessories).

➡ Divider bars on the back...

#52000 | 9/17/2018



Center divider bars have notches to accept interlocking side divider bars.

- Provides stability for pan placement by preventing side bars from sliding out of position that could allow pans to fall into cabinet below.
- Increased flexibility for user because center notches allow user to easily re-configure bars to accept desired pan sizes for their unique menu.
- Made of high quality stainless steel insures long life.

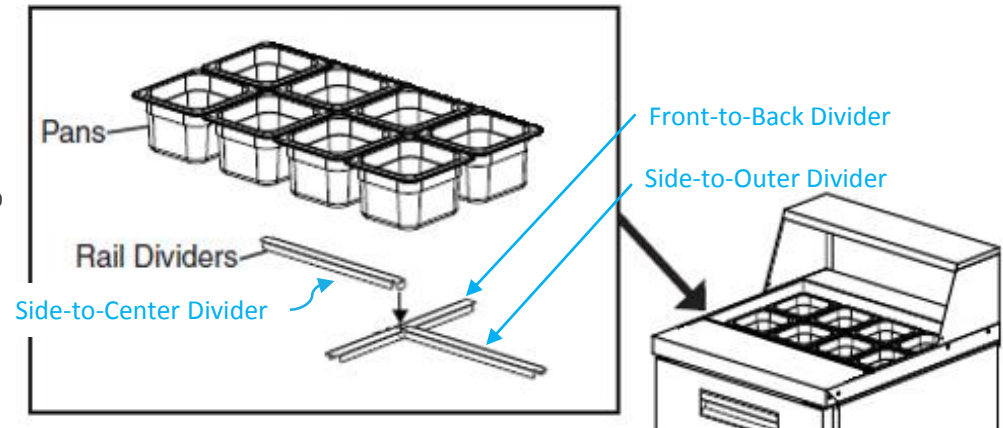

Front-to-Back Divider		Side-to-Outer Divider			Side-to-Center Divider		
HS-5187 27-8 One divider bar per kit	HS-5188 All Others One divider bar per kit	HS-5185 27-8 One divider bar per kit	HS-5189 -8, -16 One divider bar per kit	HS-5191 -18 One divider bar per kit	HS-5186 -10 One divider bar per kit	HS-5190 -12, -16 One divider bar per kit	HS-5192 -18 One divider bar per kit

INCLUDED DIVIDER BARS

CRMR27-8

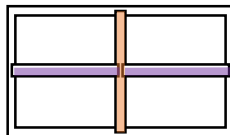

- (1) **HS-5187**: Front-to-Back Divider (13-3/4"; 348 mm)
- (2) **HS-5185**: Side-to-Outer Divider (12-1/2"; 319 mm)

CRMR36-10

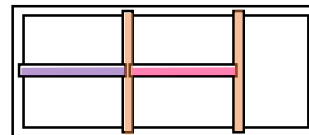

- (2) **HS-5187**: Front-to-Back Divider (13-3/4"; 348 mm)
- (1) **HS-5185**: Side-to-Outer Divider (12-1/2"; 319 mm)
- (1) **HS-5186**: Side-to-Center Divider (12-1/2"; 316 mm)

CRMR48-8, CRMR60-8

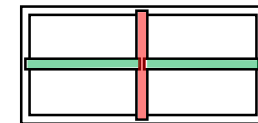

- (1) **HS-5188**: Front-to-Back Divider (12-5/8"; 322 mm)
- (2) **HS-5189**: Side-to-Outer Divider (13-5/8"; 346 mm)

CRMR48-12, CRMR60-12, CRMR72-12



- (2) **HS-5188**: Front-to-Back Divider (12-5/8"; 322 mm)
- (2) **HS-5189**: Side-to-Outer Divider (13-5/8"; 346 mm)
- (1) **HS-5190**: Side-to-Center Divider (13-1/2"; 344 mm)

CRMR60-16, CRMR72-16

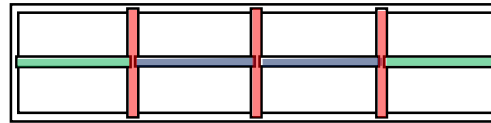

- (3) **HS-5188**: Front-to-Back Divider (12-5/8"; 322 mm)
- (2) **HS-5189**: Side-to-Outer Divider (13-5/8"; 346 mm)
- (2) **HS-5190**: Side-to-Center Divider (13-1/2"; 344 mm)

CRMR72-18



- (2) **HS-5188**: Front-to-Back Divider (12-5/8"; 322 mm)
- (2) **HS-5191**: Side-to-Outer Divider (20-5/8"; 523 mm)
- (1) **HS-5192**: Side-to-Center Divider (20-1/2"; 520 mm)