



Ice Machine Cleaning & Sanitizing

HOSHIZAKI

F-450MAJ(-C)
FD-650MAH-C, MWH-C, MRH-C
F-801MAJ(-C), MWJ(-C)
F-1002MAJ(-C), MWJ(-C), MRJ(-C), MLJ
FD-1002MAJ-C, MRJ-C
F-1501MAJ(-C), MWJ(-C), MRJ(-C)
F-2001MWJ, MRJ/3(-C), MLJ

The icemaker and dispenser must be cleaned & sanitized at least twice a year.

Cleaning Prep:

- 1 Close the icemaker water supply line shut-off valve.
 - 2 Remove the **Front Panel**, move the **control switch** to **DRAIN**. Make sure the **power switch** is **ON**. Replace the **Front Panel**.
 - 3 Allow the water system to drain completely. Remove the **Front and Top Panels**, move the **power switch** to **OFF**.
 - 4 Remove all ice from the ice storage bin and/or dispenser.
- ATTENTION!** IF ON DISPENSER, turn off the dispenser power supply after dispensing all the leftover ice.



ATTENTION!

DO NOT leave icemaker unattended when panels are off

AMMONIA Cleaners



Sanitizing:

- Dilute 5.25% chlorine bleach[‡] with warm water (see Table below)

Sanitizing Solution	
Bleach	9.6 fl. oz (0.29 l)
Warm Water	1.6 gal. (6.0 l)

[‡] Use bleach without additives.

- Remove the front and top panels
- Move the power switch to OFF
- Remove the spout-to-chute strap (includes drip guide on F-1501 and larger)
- Remove the spout

- Pour the sanitizing solution over the extruding head until the evaporator assembly and reservoir are full, and the solution runs out the overflow hose

- Replace the spout, spout-to-chute strap, and drip guide (if applicable) in their correct positions.

- Allow the icemaker to sit for 10 minutes before operation

- Move the control switch to ICE

- Move the power switch to ON
- Replace the panels in their correct positions

- Make ice using the solution until the icemaker stops making ice

Cleaning:

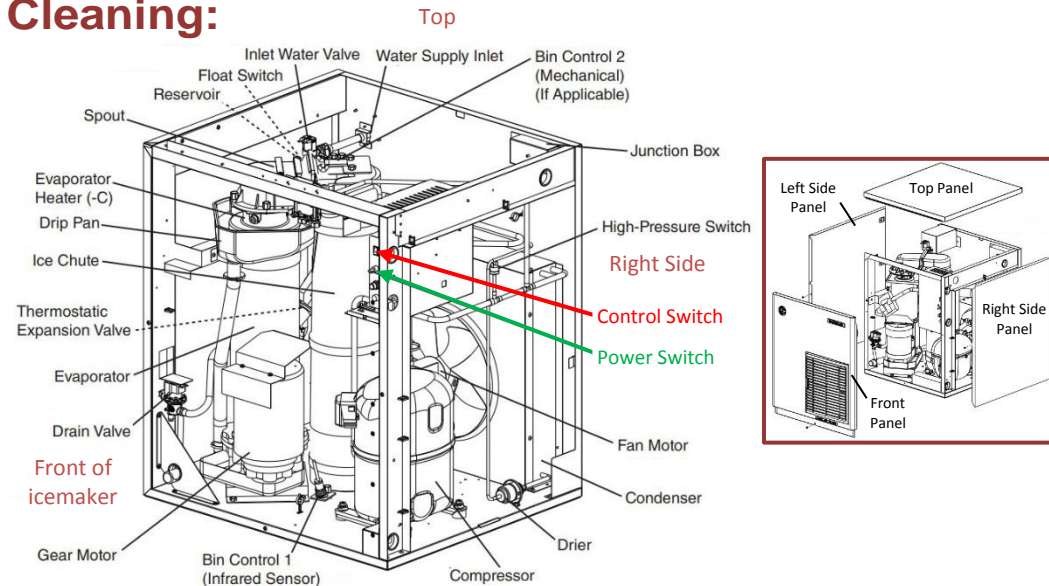

- 5 Remove the **Spout-to-Chute Strap** (includes **Drip Guide** on F-1501 and larger), then remove the **Spout**.
- 6 Dilute Hoshizaki **Scale Away** with warm water (see Table).

Cleaning Solution	
Scale Away	9.6 fl. oz (0.29 l)
Warm Water	1.6 gal. (6.0 l)

Pour the cleaning solution over the **Extruding Head** until the **Evaporator Assembly** and **Reservoir** are full, and the solution runs out through the **Overflow Hose**.



Replace the **Spout, Spout-to-Chute Strap, and Drip Guide** (if applicable) in their correct positions.

Allow the icemaker to soak for 10 minutes.

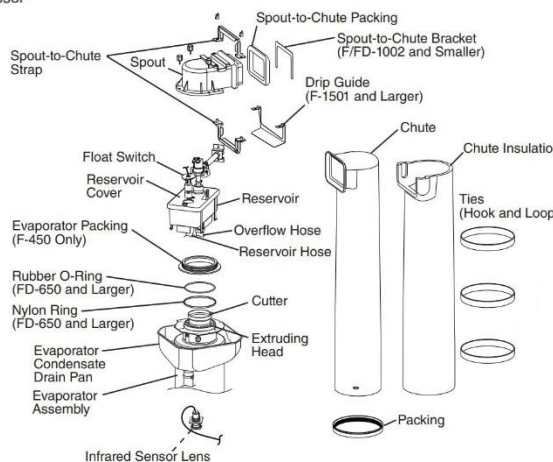

↪ continued on the back...

7 In bad water conditions, a more thorough soaking may be required. Remove the **Left Side Panel** and remove the **Float Switch** from the **Reservoir cover**. Clean the **Float Switch** with the solution, rinse thoroughly with clean water, and replace it back in the cover. Follow Step **6**, then place a clamp on the **Reservoir Hose** that will block the flow to the **Evaporator Assembly**. Pour additional cleaning solution over the **Extruding Head** until the **Evaporator Assembly** is full.

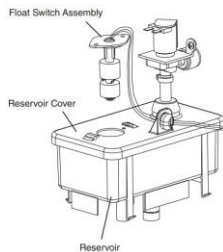

Allow to soak for 10 minutes, remove the clamp before operation.

Otherwise, continue to Step **8**.

8 Wipe down the **Infrared Sensor Lens**, (located on the bottom of the icemaker). Rinse the lens with a clean, damp cloth.

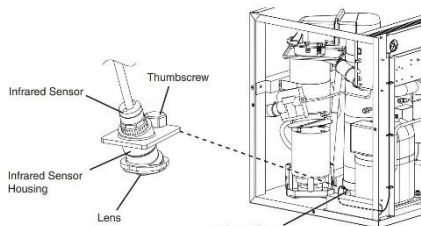

9 Move the **control switch** to **ICE**, then move the **power switch** to **ON**. Replace the panels in their correct positions. Make ice using the cleaning solution until it stops.

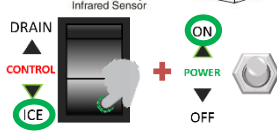

10 Remove the **Front Panel**. Move the **control switch** to **DRAIN**, then replace the **Front Panel**. Allow the icemaker to drain completely.

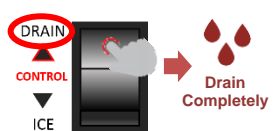

11 Remove the **Front Panel**. Move the **power switch** to **OFF**. Open the water supply line shut-off valve to supply water to the icemaker.

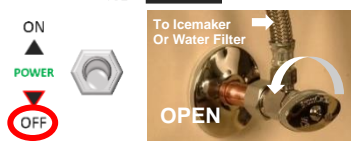

12 Move the **control switch** to **ICE** and the **power switch** to **ON**. Allow the icemaker to fill the reservoir with water.



13 After the gear motor starts, move the **control switch** to **DRAIN**. Replace the **Front Panel**. Allow the icemaker to drain completely.



i The icemaker might make a noise/squealing when first started due to scale removal from auger/evaporator. This is normal in bad water conditions and will subside after 20 minutes.

14 Remove the **Front Panel**. Move the **power switch** to **OFF**. Replace the **Front Panel**. Close the icemaker water supply line shut-off valve.



Continue to **Sanitation – Step 15 on front...**

- ↓ sanitizing continued...
- Remove the front panel **19**
 - Move control switch to DRAIN, replace the front panel
 - Allow the icemaker to drain completely
 - Remove the front panel **20**
 - Move power switch to OFF
 - Open the icemaker water supply line shut-off valve
 - Move control switch to ICE **21**
 - Move power switch to ON
 - Allow the icemaker to fill the reservoir with water
 - After the gear motor starts, move the control switch to DRAIN **22**
 - Replace the front panel
 - Allow the icemaker to drain completely
 - Remove the front panel **23**
 - Move the control switch to ICE, replace the front panel
 - Allow the icemaker to run for 30 minutes or produce a batch of ice
 - Remove the front panel **24**
 - Move the power switch to OFF
 - Pour warm water into the dispenser/storage bin to melt any remaining ice
 - Clean the dispenser/storage bin liner and cover with dish soap and a damp cloth. Rinse thoroughly with clean water
 - Move the power switch to ON, replace the front cover

DOWNLOAD COMPLETE INSTRUCTION MANUAL:



hoshizakiamerica.com/manuals

Type in the model number of your icemaker (including dashes) to download manuals

CLEANING SCHEDULE

- **Air Filter/Scoop** Dish soap, rinse well
 - **Water Filters** Check psi, change if req'd
 - **Exterior** Stainless Steel Cleaner
 - **Underside/Top Kit** Dish soap & damp cloth
 - **Icemaker/Dispenser** Follow these instructions
 - **Water Supply Inlet** Clean inlet screen/valves
 - **Extruding Head** Inspect seal bolts/ bearing wear. Tighten or replace
 - **Water Hoses** Inspect. Replace if req'd
- **WEEKLY** | ● **MONTHLY** | ● **BI-ANNUAL**

! ATTENTION!

DO NOT use ammonia type cleaners. Can cause damage to icemaker

WEAR liquid-proof gloves and goggles to protect skin & eyes from cleaning & sanitizing chemicals

! ATTENTION!

IF ICEMAKER IS ON DISPENSER, remember to turn on the dispenser after cleaning

