



F-801M_J(-C)

Modular Ice Machine Slim-Line Series



F-801M_J(-C)
03/31/17
Item # 13037

Item #: _____
 Project: _____
 Qty: _____
 AIA#: _____

W x D x H
22" x 27^{3/8}" x 26"

F-801MAJ ★
Air-Cooled Flaker

F-801MWJ
Air-Cooled Flaker

F-801MAJ-C ★
Air-Cooled Cubelet

F-801MWJ-C
Air-Cooled Cubelet



Features

- ▶ Durable stainless steel exterior
- ▶ Advanced CleanCycle24™ design 
- ▶ Stainless steel auger with greaseless bearing
- Flaker - Up to 751 lbs. of ice production per 24 hours
- Cubelet - Up to 690 lbs. of ice production per 24 hours
- Mount two units, side-by-side, in only 44" of floor space for double the amount of ice production
- 2 second flush cycle every hour
- Flush cycle removes sediment for cleaner ice
- Infrared bin control for easy cleaning and reliability
- R-404A Refrigerant

Available on Bins:

B-250PF B-500PF/SF B-800PF/SF B-1150SS B-1500SS*
B-300PF/SF B-700PF/SF B-900PF/SF B-1300SS B-1650SS*

*Top kit may be required. See Bin Spec Sheets. *Two unit application only.*

Warranty:

3 Year Parts & Labor on entire machine. 5 Year Parts on Compressor; air-cooled condenser coil. Valid in United States, Canada, Puerto Rico and U.S. Territories. Contact factory for warranty in other countries.



Condenser	Model	ICE PRODUCTION			WATER USAGE			ELECTRICAL			Heat Rejection BTU/hr.	Shipping Weight	ENERGY STAR®
		Air / Water Temp Lbs. per 24 hours 70°/ 50°F 90°/ 70°F	Type of Ice (Hardness Rating)	Potable Gal. per 100 lbs. 90°/ 70°F	Condenser Gal. per 100 lbs. 90°/ 70°F	kWh Used per 100 lbs. 90°/ 70°F	Max. Fuse Size or HACR Circuit Breaker	Amperage	Voltage				
Air-Cooled	F-801MAJ	751	566 Flaked (79.4)	12.0	N/A	4.5	15A	11.8A	115V/60/1	5,900	205 lbs.	★	
Water-Cooled	F-801MWJ	680	605 Flaked (76.9)	12.0	119	3.9	15A	11.8A	115V/60/1	6,200	205 lbs.		
Air-Cooled	F-801MAJ-C	690	532 Cubelet (86.6)	12.0	N/A	5.00	15A	11.8A	115V/60/1	5,000	205 lbs.	★	
Water-Cooled	F-801MWJ-C	632	580 Cubelet (82)	12.0	120	4.13	15A	11.5A	115V/60/1	6,000	205 lbs.		

Cube Dimensions*

Flaked
F-801MAJ

Cubelet
F-801MAJ-C

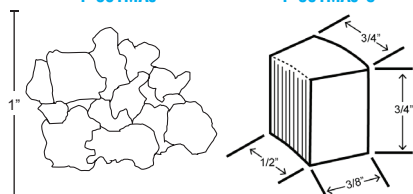

* approximate size in inches, image not to scale

Operating Limits

- Ambient Temp Range 45 - 100°F
- Water Temp Range 45 - 90°F
- Water Pressure 10 - 113 PSIG
- Voltage Range 104-127V

Service

- Panels easily removed and all components accessible for service.
- Removable/cleanable air filter (Air-cooled model only)
- Allow 6" (15 cm) clearance at rear and sides, and 24" (61 cm) clearance at top for proper air circulation and ease of maintenance/service.

Plumbing

- Icemaker Water Supply Line: Minimum 1/4" Nominal ID Copper Water Tubing or Equivalent
- Icemaker Drain Line: Minimum 3/4" Nominal ID Hard Pipe or Equivalent

Water-Cooled Model (Lines Must Be Independent of Icemaker)

- Condenser Water Supply Line: Minimum 1/4" Nominal ID Copper Water Tubing or Equivalent
- Condenser Drain/Return Line: Minimum 1/4" Nominal ID Hard Pipe (open drain system) or Copper Water Tubing (closed loop system) or Equivalent



F-801M_J(-C)

Modular Ice Machine
Slim-Line Series



F-801M_J(-C)
03/31/17
Item # 13037

FRONT VIEW

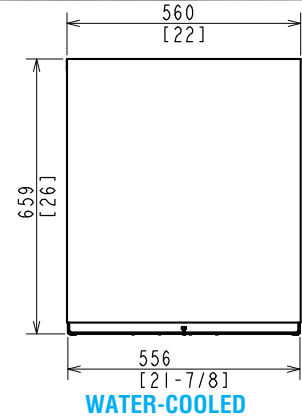
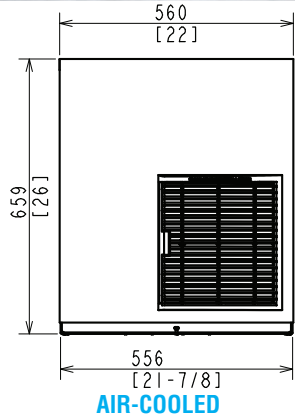

mm
[inch]

SIDE VIEW

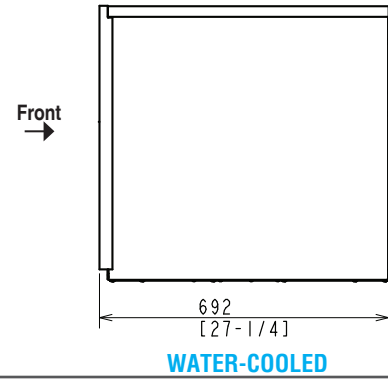
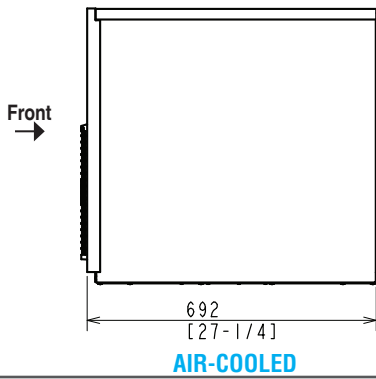

REAR VIEW

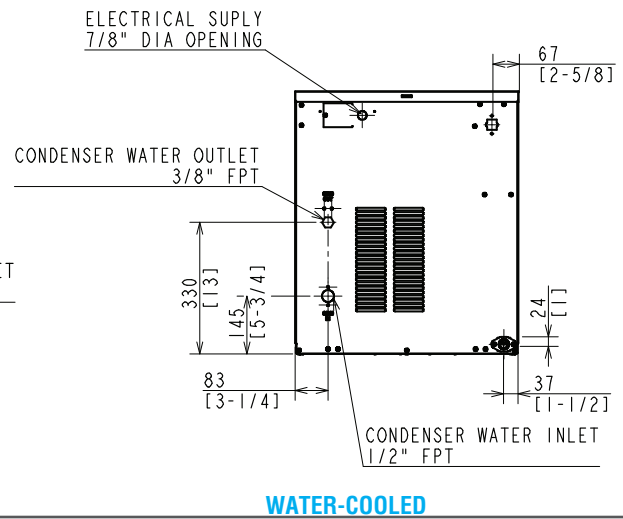
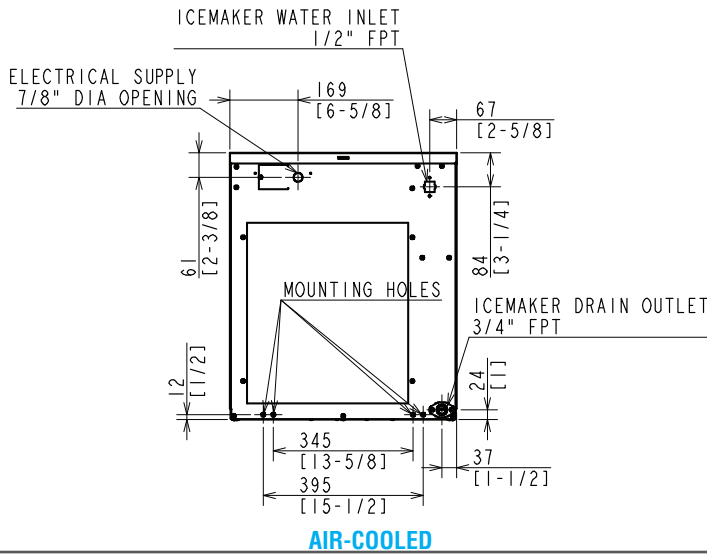

BOTTOM VIEW

