



# RH1-2-SSE-HG

## Professional Series Reach-in Refrigerators



RH1-2-SSE-HG  
10/14  
Item # 13252

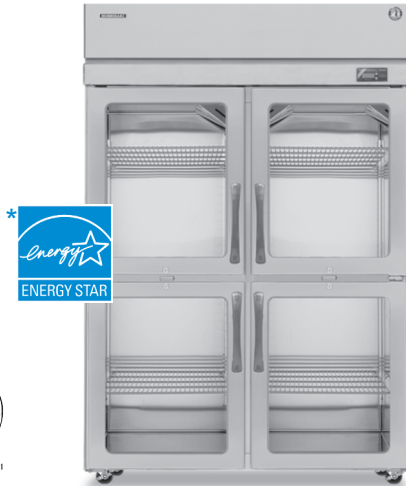

- Stainless steel interior and exterior
- Energy efficient thermostatic expansion valve self contained refrigeration system
- Innovative **Variable Speed Compressor** with "adaptive control" technology
- EverCheck® digital control system with audio alarms
- Entire cabinet is insulated with 2 3/8" foamed in place polyurethane
- Unique "ducted" air distribution system
- Glass doors are energy efficient Triple Pane, Argon filled with Low-E non reflective coating and locks
- Dual door frame heaters with energy saving on/off switch
- All metal torsion spring hinge design with stay open feature
- Exclusive "stepped" door design to protect recessed door gasket
- Rugged, die cast aluminum door handles
- Field reversible doors (with optional kit)
- Epoxy coated evaporator coil
- Hinged upper front panel for easy access to controller
- Removable, cleanable refrigeration system air filter
- Energy efficient automatic hot gas condensate evaporator
- (3) Epoxy coated wire shelves per section
- Standard with 4" factory installed casters (two with brakes)
- Three years parts and labor warranty
- Five year compressor warranty
- 8 ft. cord and plug

\* RH2 is ENERGY STAR qualified

### Dimensions / Capacity

Model #	One Section RH1-SSE-HG	Two Section RH2-SSE-HG
Interior Storage Capacity (CF)	22.3 ft <sup>3</sup>	48.0 ft <sup>3</sup>
Overall Width x Depth	27.5" x 33.6"	56" x 33.6"
Height (including 4" casters)	82.5"	82.5"
Door Opening Width x Height	21.75" x 26.75"	21.75" x 26.75"
Depth with Door open at 90°	58.5"	58.5"
Adjustable Shelves	3	6
Center Shelves	-	3
Shelf Dimensions (W x D)	21.25" x 26"	21.25" x 26"
Crated Shipping Weight	400 lbs	625 lbs
Crated Height x Width x Depth	85" x 32" x 38"	85" x 59" x 38"

### Electrical & Refrigeration Data

Model #	One Section RH1-SSE-HG	Two Section RH2-SSE-HG
Amperage	4.3	6.0
Energy Consumption (kwh/day) ENERGY STAR	3.0	3.9
Heat Rejection (BTU/Hr.)	655	981
Approx. Nominal Compres. BTU/HR(HP)	1970 @ 4000(1/2HP)	2661 @ 4000(2/3HP)

Hoshizaki America, Inc. reserves the right to change specifications without notice.

Item #

Project:

Qty:

\*AutoCad available on KCL

### RH-SSE-HG Dimensions W x D x H

1 Section - 27.5" x 33.6" x 82.5"\*

2 Section - 55" x 33.6" x 82.5"\*

\*with 4" casters

### Electrical/Refrigeration

**Voltage** - 115/60/1

**HACR Breaker** - 15.0

**Electrical Connection** - 5-15P  
(NEMA)

**Voltage Range** 80 - 140

**Ambient Temp. Range** 45°-100°F

**Control Setpoint Range** 36°-50°F

\*Refrigerant R-134A

### Warranty

Valid in United States, Canada, Puerto Rico, and U.S. Territories. Contact factory for warranty in other countries.

- **Three Year** - Parts & Labor on entire machine.
- **Five Year** - Parts on: Compressor.

### Options

- 6" legs with stainless steel bullet feet
- Door reversal kit
- Additional epoxy shelves
- Stainless steel shelves
- Patented foot pedal door opener
- Combination universal tray/pan slides
- Door padlock hasp
- NAFEM Data Protocol connection (Software by other vendors)



© HOSHIZAKI AMERICA, INC.

618 Hwy. 74 S., Peachtree City, GA 30269  
TEL 800-438-6087  
FAX 800-345-1325  
www.hoshizaki.com



# RH1-2-SSE-HG

## Professional Series Reach-in Refrigerators

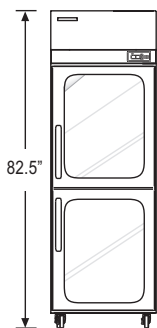

RH1-SSE-HG

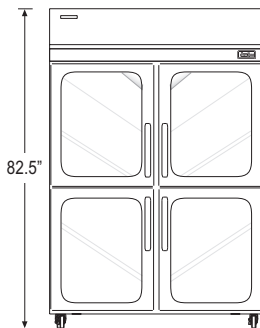

RH2-SSE-HG

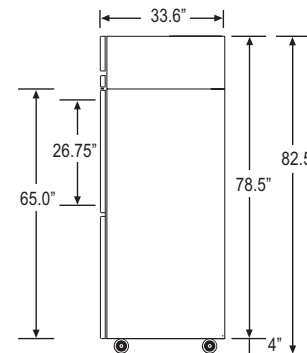

SIDE VIEW (ALL UNITS)

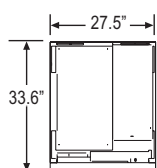

PLAN VIEW

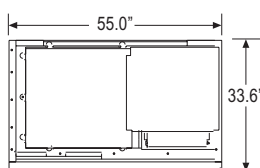

PLAN VIEW

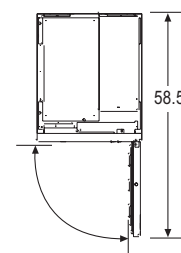

DOOR SWING (ALL UNITS)

### Cabinet Construction

The exterior cabinet front, sides, shrouds and hinged front panel are constructed of high quality stainless steel. The exterior top, back and bottom are made from galvanized steel. The cabinet interior walls and ceiling are stainless steel. The floor is stainless steel with coved corner construction. The "ducted" air flow system is also constructed of heavy gauge stainless steel. Heavy duty ABS thermal breaks are used to reduce heat transfer. Three (3) heavy duty epoxy coated shelves per section are standard (and include center shelves on two and three section models). Mounted on stainless steel pilasters the shelves are adjustable in 1" increments. The cabinet door perimeter heater provides condensation control in high humidity environments and is equipped with a back-up heater should the primary fail. A manual power switch allows for energy savings in low humidity conditions. Cabinet walls and doors are insulated with 2 3/8" of environmentally friendly R-134A, CFC free foamed in place polyurethane. The interior light is automatically activated when doors are opened. 4" factory installed casters (2 with brakes) are standard.

### Door Construction

Glass door frames are constructed of high grade stainless steel inside and out and are standard with locks. Door glass is energy efficient triple pane, argon filled with Low-E non reflective coating. The door hinges are all metal and include an adjustable torsion spring closure that will not wear out like traditional cam-lift hinges. Hinge plates are constructed of eight (8) gauge stainless steel and include a welded hinge pin. Doors stay open at 105° and are self-closing at 75°. Snap-in magnetic door gaskets are durable and easily removed for cleaning. Door hinging is field reversible (with an optional door reversal hinge kit).

### Refrigeration System

The high efficiency self contained refrigeration system is designed using a state of the art variable speed compressor with "Adaptive Control" technology as well as electronically controlled fan motors resulting in even greater energy savings. The primary objective of the variable speed refrigeration system is for the compressor to run at the slowest motor RPM level possible to meet the cooling requirements of the refrigerator. Traditional compressor motors have only one speed; they are either on or off.

The refrigeration system components are mounted on a fully insulated roto-cast (ABS) housing that is removable from the main unit. All heat exchange takes place above and outside the food zone and allows for 100% utilization of the interior storage area. The ducted air distribution system achieves a uniform cabinet temperature eliminating "hot spots", even when fully loaded with product. The evaporator coil is epoxy coated for extended life. Stainless steel refrigerant tubing is used as the hot gas condensate evaporator. A thermostatic expansion valve controls the flow of R-134A refrigerant. A removable, cleanable air filter protects the condenser coil and helps reduce cleaning requirements of the refrigeration system. 115 volt units are equipped with an eight foot cord and plug (20.0 amps or less).

The EverCheck® Digital Control System monitors the operation and performance of the refrigeration system and is standard on all Professional Series units. The EverCheck® includes solid state controls to maintain optimum cabinet temperature, and monitor high and low temperatures, high pressure, high and low voltage, clean filter, door open and evaporator temperature functions. It also provides audio and visual alarms to alert the operator to possible problems. An LED display shows the cabinet temperature and is adjustable to Fahrenheit or Celsius. The EverCheck® control system is NAFEM Data Protocol ready and requires optional hardware for implementation (monitoring software by other vendors).