



WF60A

Worktop 60" Freezer



WF60A
11/19/18
Item # 13434

W x D x H
60" x 30" x 40"*
*with 6" casters



Item #: _____
Project: _____
Qty: _____
AIA#: _____

Features

- ▶ Engineered to maintain NSF-7 temperatures in 100°F ambient.
- ▶ Stainless steel exterior front, sides, and top with stainless steel interior top, sides, back, and floor
- ▶ Front breathing air flow design
 - Environmentally friendly R290 hydrocarbon refrigerant
 - Cabinet and doors are insulated with 2" CFC free, foamed in place polyurethane
 - Exclusive "stepped" door design to protect door gasket
 - Spring assisted self-closing doors with stay open feature
 - Extruded aluminum flush mount door handle
 - Field reversible doors
 - Magnetic door gasket is easily removable for cleaning
 - E-coated evaporator coil
 - One epoxy coated shelf per section is standard
 - Anodized aluminum shelf supports adjustable in 1/2" increments
 - Standard with 6" casters (two with brakes)
 - 10 ft. cord and plug



Dimensions / Capacity	Two-Section WF60A
Interior Storage Capacity (CF)	17.55 ft ³
Interior Storage Capacity (CF) (AHAM)	15.38 ft ³
Overall Width x Depth (including 1" bumper)	60" x 31"
Height (including 4" casters)	40"
Door Opening Width x Height	25.5" x 23"
Depth with Door Open at 90° (including 1" bumper)	58.5"
Adjustable Shelves	2
Shelf Dimensions (W x D)	27.25" x 16"
Crated Weight	272 lbs.
Crated Length x Width x Height	62" x 34" x 40.5"
Electrical / Refrigeration	Two-Section WF60A
Voltage	115/60/1
HACR Breaker	15.0 Amps
Electrical Connection (NEMA)	5-15P Ⓢ
Voltage Range	104-126
Ambient Temp. Range	45° to 100°F
Control Setpoint Range	-10° to 10°F
Amperage	5.6
Energy Consumption (kWh/day) @ASHRAE	4.22
Heat Rejection (BTU/Hr.) @NSF	804.2
Approx. Nominal Compres. BTU/HR (HP)	1360 (1/3HP)
Refrigerant / Charge Amount (oz)	R290 (3.9 oz)

Options

- 2.25" Casters
 - 4" Casters
 - Stainless steel back
 - Cylinder locks (-01 factory installed)*
 - Additional epoxy shelves
 - Overshelves
- * SPECIAL ORDER- Allow 4-6 weeks lead time.

Warranty

- * 3 Year - parts and Labor on entire machine.
 - 5 Year - Parts on Compressor
- Valid in United States, Canada, Puerto Rico and U.S. Territories. Contact factory for warranty in other countries.

Hoshizaki reserves the right to change specifications without notice.



WF60A

Worktop 60" Freezer

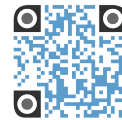

WF60A
11/19/18
Item # 13434

FRONT VIEW

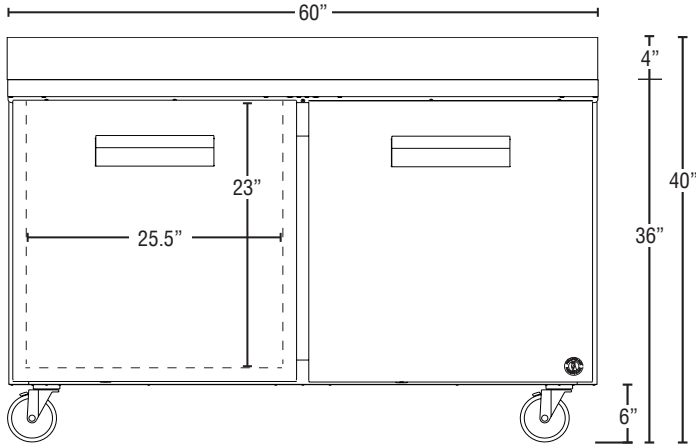

SIDE VIEW

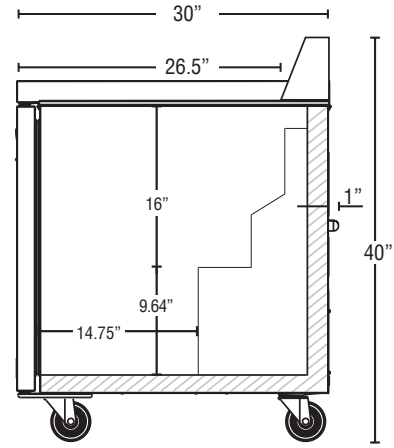

PLAN VIEW

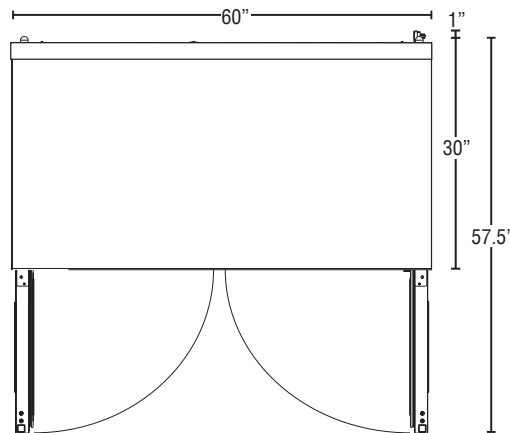

Cabinet Construction

The exterior cabinet top, front, and sides, are constructed of high quality stainless steel. The exterior back and bottom are constructed of coated steel. The cabinet interior features stainless steel back, sides, and floor with a stainless steel top. One heavy duty epoxy coated shelf per section is standard. Mounted on anodized aluminum pilasters the shelves are adjustable in 1/2" increments. Cabinet are insulated with 2" CFC free foamed in place polyurethane. 4" polyolefin, stem casters (two with brakes) are standard.

Door Construction

Doors are constructed of high grade stainless steel exterior with an ABS interior liner and are insulated with 2" CFC free foamed in place polyurethane. Hoshizaki's exclusive "stepped" design protects the gasket while product is removed from the cabinet. Doors are provided with a one piece, extruded aluminum, flush mount handle. Spring assisted self-closing doors are equipped with a stay open feature past 90° degrees. Snap-in magnetic door gaskets are durable and easily removed for cleaning. Field reversible door hinging is standard and does not require a kit.

Refrigeration System

The high efficiency refrigeration system is self-contained with an E-coated evaporator for extended life. Condensate removal is accomplished with an energy efficient non-electric evaporation system. A capillary tube controls the flow of environmentally friendly R290 refrigerant through the evaporator. Unit uses a heated, time initiated defrost defrost to eliminate any ice on the evaporator coil. 115 volt units are equipped with a ten foot cord and plug (20.0 amps or less).