



# HOSHIZAKI

## Parts List

Cubelet Icemaker/Dispenser

Models

DWM-20A



[hoshizakiamerica.com](http://hoshizakiamerica.com)

Number: 71448  
Issued: 7-1-2024

## CONTENTS

Note About Ordering Parts .....	2
A. Hardware and Cabinet.....	3
B. Electrical Components .....	4
C. Miscellaneous .....	5

### **Auxiliary Code Breakdown**

The auxiliary code is the first two characters in the serial number. The first character indicates the year. Years progress or regress in alphabetical order. The series runs from "A" through "V" and the letters "I" and "O" are skipped. The second character indicates significant part changes within a year. Base is "0" and this number advances for each change. In cases where there is a letter in parentheses, this designates the month. This is the last character in the serial number. The series runs from "(A)" through "(M)" and the letter "(I)" is skipped. This designation is only included when identifying a parts change within an auxiliary code.

### **Note About Ordering Parts**

Most assemblies cannot be ordered as complete units; parts in the assemblies generally must be ordered separately.

# A. Hardware and Cabinet DWM-20A

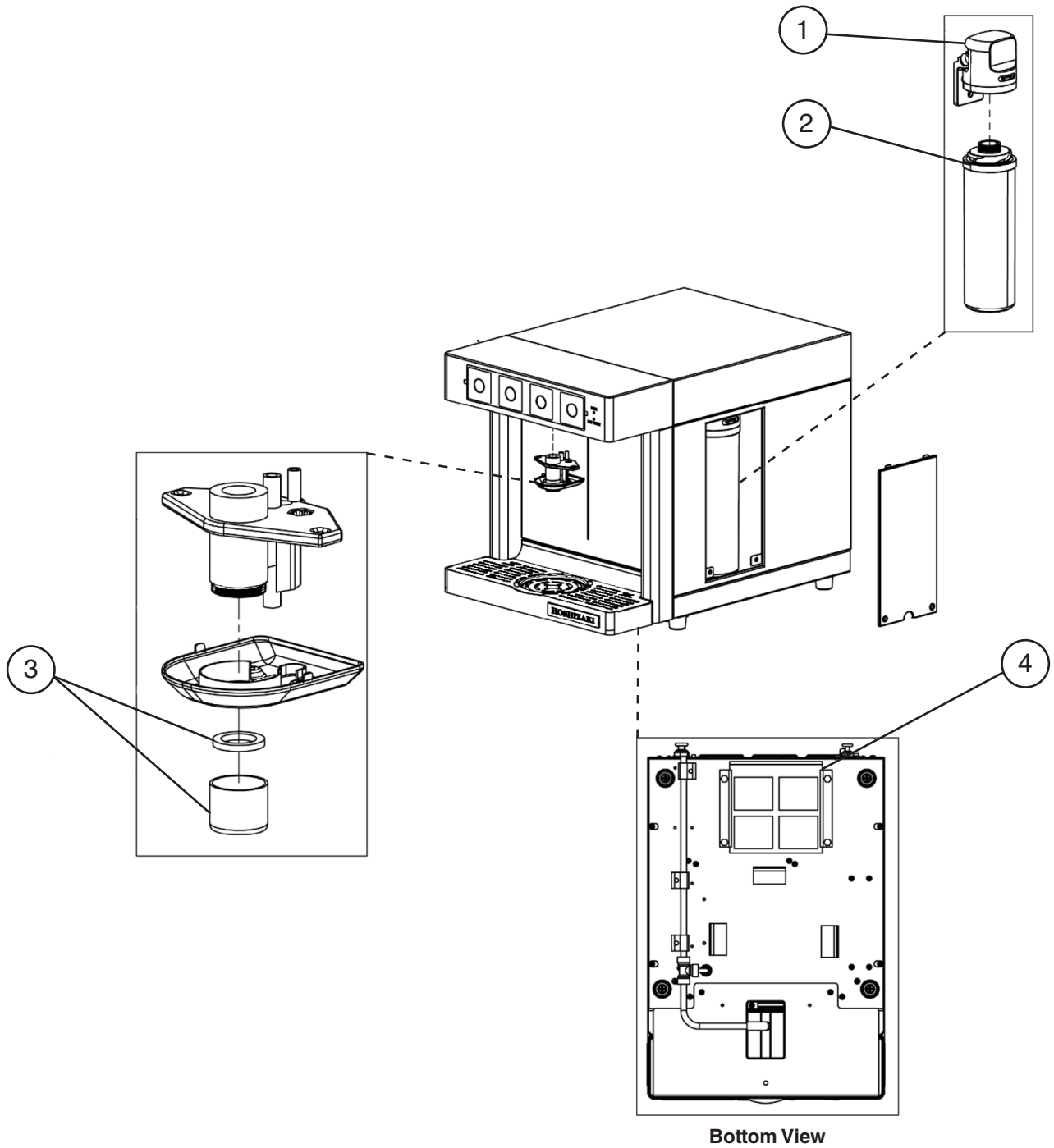

Title: A. Hardware and Cabinet		Model: DWM-20A		Required Number							
Index No.	Description	Material or Model Number	Part Number	-							
1	Alkaline Chamber Head		HC1-S1P14	1							
2	Alkaline Chamber (HS-5442)		HC1-S1P15	1							
3	Nozzle Gasket/ Nozzle Tip w/Aerator		HC1-S1P18	1							
4	Air Filter		HC1-S1P19	1							

## B. Electrical Components DWM-20A

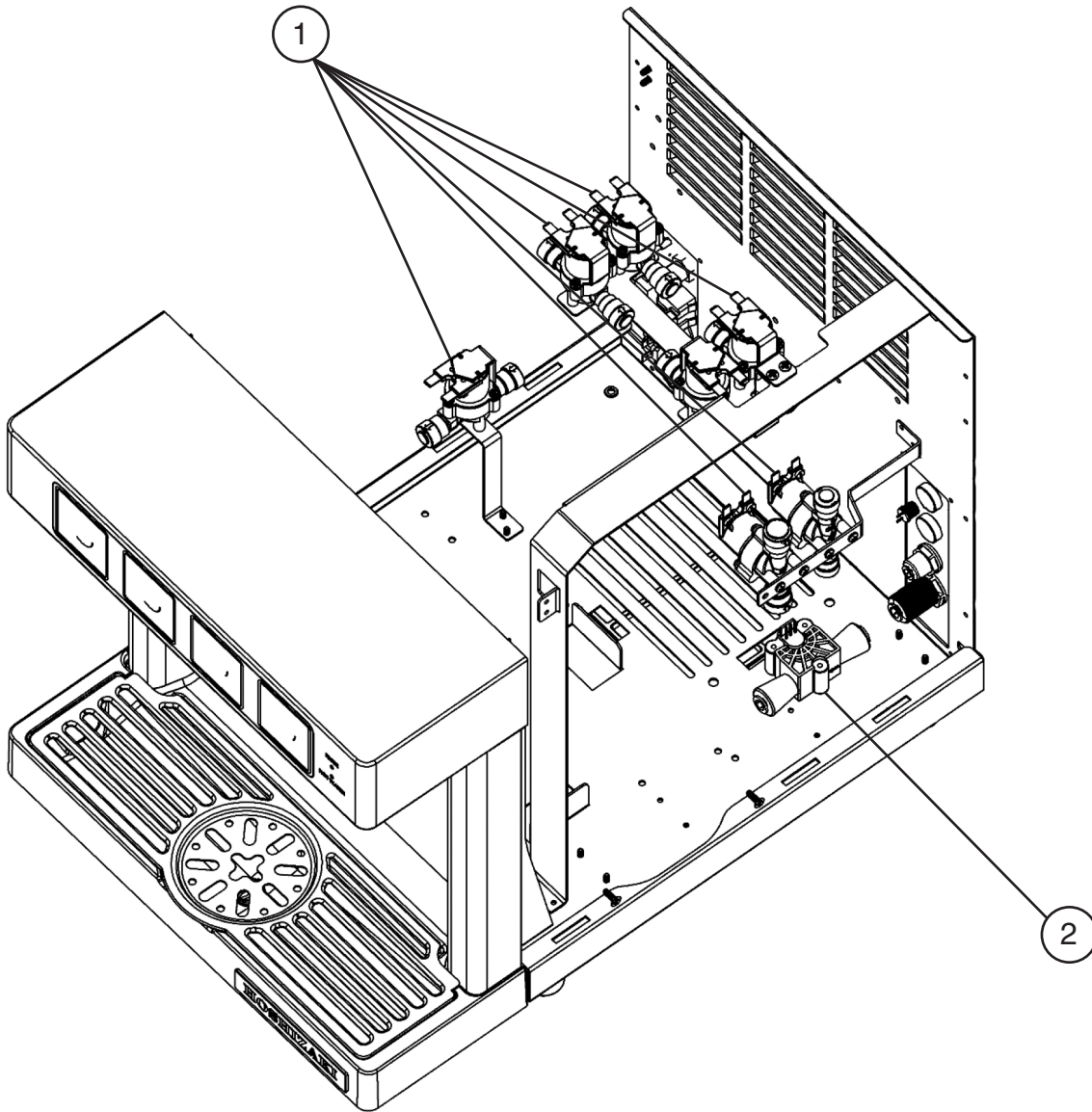

Title: B. Electrical Components Model: DWM-20A												
Index No.	Description	Material or Model Number	Part Number	Required Number								
				-								
1	Main Solenoid Valve		EE1-S1P08	1								
2	Flow Meter		EE1-S1P09	1								

**C. Miscellaneous**  
**DWM-20A**

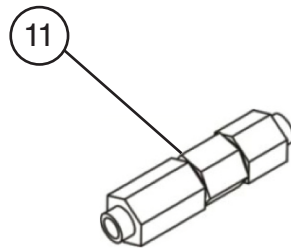
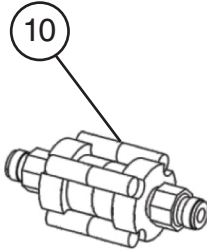
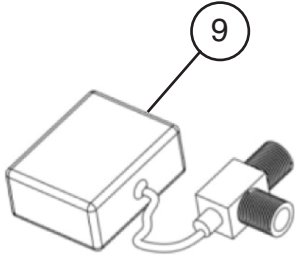
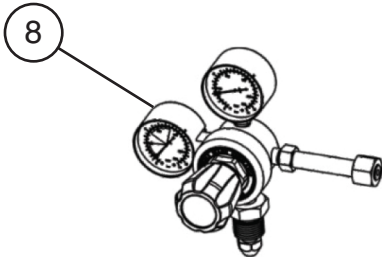
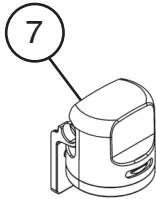
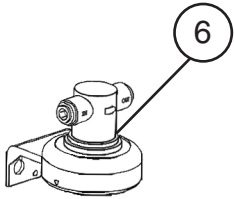
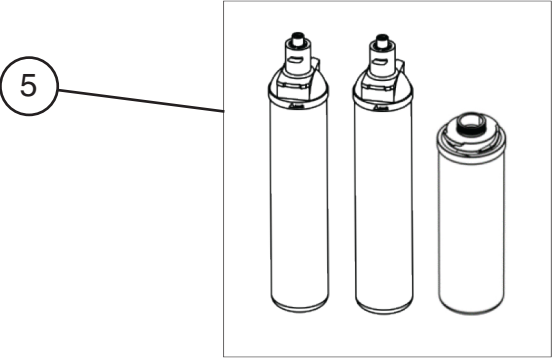
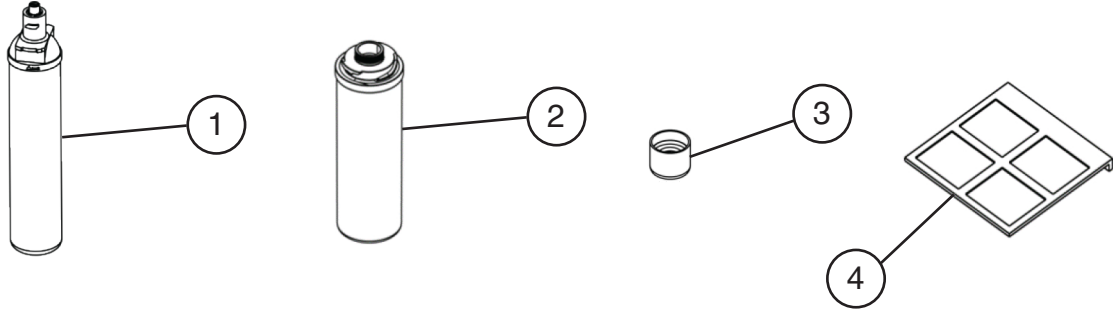

Title: C. Miscellaneous Model: DWM-20A												
Index No.	Description	Material or Model Number	Part Number	Required Number								
				-								
1	All-in-One Filter Cartridge		HS-5440	1								
2	Alkaline Chamber HS-5442		HC1-S2P15	1								
3	Nozzle Tip w/Aerator and Gasket		HC1-S2P18	1								
4	Air Filter		HC1-S2P19	1								
5	6 Months Replacement Kit (includes two of 1 and one of 2-4)		AL1-S1P02	1								
6	All-in-One Filter Head		AL1-S2P03	1								
7	Alkaline Chamber Head		HC1-S2P14	1								
8	CO <sub>2</sub> Gas Regulator		AL1-S2P04	1								
9	Leak Detector		AL1-S2P05	1								
10	Water Pressure Regulator		AL1-S2P06	1								
11	Backflow Prevention Valve ASSE 1032		AL1-S2P07	1								